

22.09.2025

User Manual LiNX

## REMOTES

- DLX-REM400
- DLX-REM500

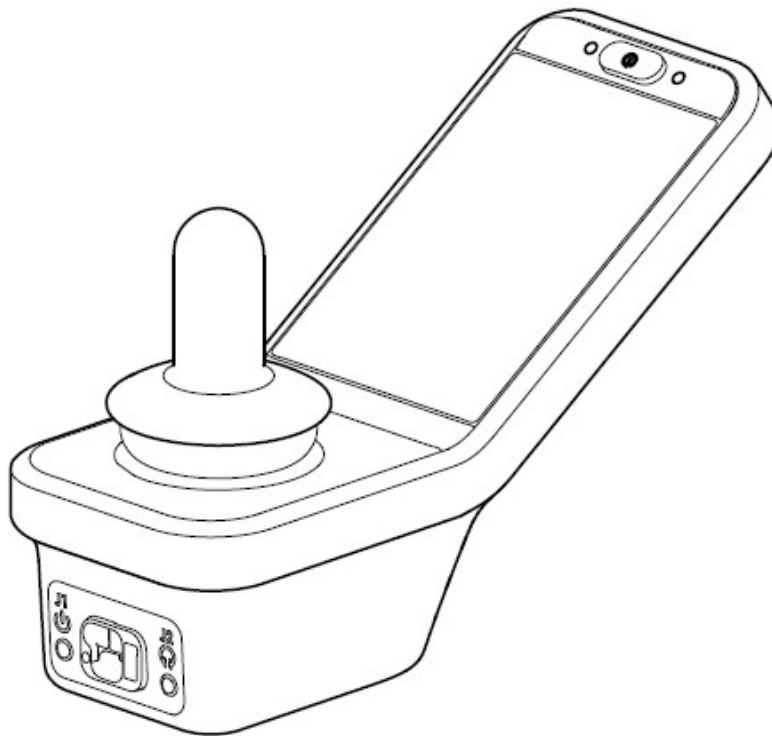

Please note that due to variations or special requirements in the various markets, there may be additional information as appendices or included in the user guide.

For the visually impaired, this and other guides can be downloaded from our website and enlarged on a PC or other electronic aid.

# CONTENTS

<b>1. INTRODUCTION</b>	4
1.1. About this manual	4
1.2. Use of hazard symbols	4
1.3. Available documentation	5
1.4. The environment	5
1.5. Warranty	5
1.5.1. Terms of warranty	5
1.5.2. Warranty Exclusions	5
1.5.3. Service and support	5
<b>2. SAFETY</b>	6
2.1. General safety notes	6
<b>3. COMPONENTS</b>	8
3.1. User interface	8
3.2. Screen composition overview	9
3.2.1. Battery bar	9
3.2.2. Status Bar	10
3.2.3. User Function Card Overview	11
3.3. Navigation button	17
<b>4. USAGE.</b>	18
4.1. Operating the remote	18
4.1.1. Powering up / down the remote	18
4.1.2. Using the multipurpose buttons	18
4.1.3. Using the Toggle Switches (Optional)	19
4.2. Operating the drive function	19
4.2.1. Using the joystick	19
4.2.2. Controlling the maximum speed	20
4.2.3. Emergency stop	20
4.2.4. USING the horn	20
4.3. Operating the light functions	21
4.3.1. USING the position lights	21
4.3.2. USING the direction indicators	22
4.3.3. USING the hazard lights	23
4.4. Operating powered seating functions	24
4.4.1. Activating seating functions	24
4.4.2. Displayed symbols and their meanings	25
4.4.3. The 10way switch module or External switches	26
4.4.4. Speed reduction and seating function inhibits	27
4.5. Operating locking and sleep function	28
4.5.1. Locking/unlocking the remote	28
4.5.2. The sleep mode	28

<b>4.6. Configuring connectivity card</b>	29
4.6.1. Pairing the LiNX system with a user’s device	29
4.6.2. Linking connectivity card with user’s device	32
4.6.3. Connecting devices with LiNX system	34
4.6.4. Removing paired devices	35
4.6.5. Disabling Bluetooth	37
<b>4.7. Charging the batteries</b>	37
4.7.1. Connecting the charger	37
<b>5. Troubleshooting</b>	38
<b>5.1. Fault diagnosis</b>	38
5.1.1. Fault codes and diagnosis codes	39
<b>5.2. OON (“Out Of Neutral”)</b>	40
<b>6. Technical Data</b>	41
6.1. Mechanical specifications	41
6.2. Electrical specifications	41
<b>7. CONTACTS</b>	42

# 1. INTRODUCTION

## 1.1. About this manual

This document is a supplement to the product's user documentation.

This component itself does not bear a CE and a UKCA mark but is part of a product that complies with the Medical Device Regulation 2017/745, Class I and Part II UK MDR 2002 (as amended) Class I concerning medical devices. It is therefore covered by the product's CE and UKCA marking. See the product's user documentation for more information.

Only use this component if you have read and understood this manual. Seek additional advice from a healthcare professional who is familiar with your medical condition and clarify any questions regarding the correct use and necessary adjustment with the healthcare professional.

Note that there may be sections in this document, which are not relevant to your component, since this document applies to all available models (on the date of printing). If not otherwise stated, each section in this document refers to all models of the component.

Baldertech reserves the right to alter component specifications without further notice.

Before reading this document, make sure you have the latest version. You find the latest version as a PDF on our website [www.baldertech.com](http://www.baldertech.com).

## 1.2. Use of hazard symbols

Symbols and signal words are used in this manual and apply to hazards or unsafe practices which could result in personal injury or property damage. See the information below for definitions of the signal words.



### **WARNING**

Indicates a hazardous situation that could result in serious injury or death if it is not avoided.



### **CAUTION**

Indicates a hazardous situation that could result in minor or slight injury if it is not avoided.

### **NOTE**

Indicates a hazardous situation that could result in damage to property if it is not avoided.

### **TIPS**

Gives useful tips, recommendations and information for efficient, trouble-free use.

### **1.3. Available documentation**

If you have problems reading this manual, it is also available in electronic format so that the text and pictures can be enlarged, etc. if so required. Contact your local dealer if you need an electronic copy. This manual and complete Technical Handbook including Service information is also available for download as a PDF file from our website [www.baldertech.com](http://www.baldertech.com).

### **1.4. The environment**

These component must be sorted at source in accordance with applicable regulations on waste. Batteries and electronic equipment in particular must be taken into account.

### **1.5. Warranty**

The terms and conditions of the warranty are part of the general terms and conditions particular to the individual countries in which this product is sold.

#### **1.5.1. TERMS OF WARRANTY**

Fulfillment of the warranty by Baldertech AS is conditional on the following terms:

Adjustments, service, and maintenance must be carried out by Baldertech AS authorized service partners.

The products must be used for their intended purpose in accordance with the Owner's Manual.

Repairs and maintenance must be carried out by skilled service personnel.

#### **1.5.2. WARRANTY EXCLUSIONS**

The Baldertech AS warranty does not apply in the following circumstances:

- If the terms of the warranty are not met
- Incorrect use of the component
- Incorrect storage and transport
- Incorrect adaptations or use of parts not supplied by Baldertech AS
- Repairs or adaptations carried out by non-Baldertech AS authorized personnel
- Damage caused by force majeure
- If the service schedule is not followed

#### **1.5.3. SERVICE AND SUPPORT**

We recommend the component to be inspected by an authorized service partner once per year for your own safety and for the product to function smoothly.

All Baldertech electronic components are identified with a unique serial number on the product label.

Always provide the serial number when contacting your supplier.

If you are in need of technical support, please contact your dealer. See "Contact Information". See "Routine Maintenance" form in Balder Service Information.

## 2. SAFETY

### 2.1. General safety notes



#### **WARNING**

Risk of injury or damage to the mobility device Do not install, maintain or operate this equipment before you have read and understood all the instructions and all the manuals for this product and all other products that you use or install together with this product.

- Follow the instructions in the user manuals.



#### **WARNING**

Risk of serious injury or damage to the mobility device or surrounding property  
Wrong settings can make the mobility device uncontrollable or unstable. An uncontrolled or unstable mobility device can cause an unsafe situation such as a crash.

- Performance adjustments must only be made by qualified technicians or by persons who completely understand the programming parameters, the adjustment process, the configuration of the mobility device and the capabilities of the driver.
- Performance adjustments must only be made in dry conditions.



#### **WARNING**

Risk of injury or damage due to electrical shorts Connector pins on cables connected to the power module can still be live even when the system is off.

- Cables with live pins should be connected, restrained or covered (with non-conductive materials) so that they are not exposed to human contact or materials that could cause electrical shorts.
- When cables with live pins have to be disconnected, for example, when removing the bus cable from the remote for safety reasons, make sure to restrain or cover the pins (with non-conductive materials).



#### **CAUTION**

Risk of injury from hot surfaces  
Remote module can get hot when exposed to strong sunlight for long periods.

- Do not leave mobility device in direct sunlight for long periods.



### **CAUTION**

Risk of injury due to unintended movement

It is recommended that the mobility device, fitted with a Gyro module, has a drive function with disabled Gyro. If the mobility device is used in a moving vehicle (e.g. boat, bus or train) maybe the Gyro function is impaired and drive demands can result in unintended movement.

- When driving on a moving vehicle choose a drive function with disabled Gyro.
- If the mobility device does not have a drive function with disabled Gyro, contact your Baldertech provider.

### **NOTICE**

Risk of damage to the connector pins

If you touch the connector pins, they can become dirty or they can be damaged by electrostatic discharge.

- Do not touch the connector pins.

### **TIPS**

Risk of damage to the mobility device There are no user-serviceable parts inside any case.

- Do not open or disassemble any case.

### 3. COMPONENTS

#### 3.1. User interface

##### DLX-REM400 front

- A - Multipurpose buttons
- B - ON/OFF button/Status LED
- C - Touch display
- D - Joystick
- E - Bus socket
- F - Stereo jack sockets
- J - Toggle switches

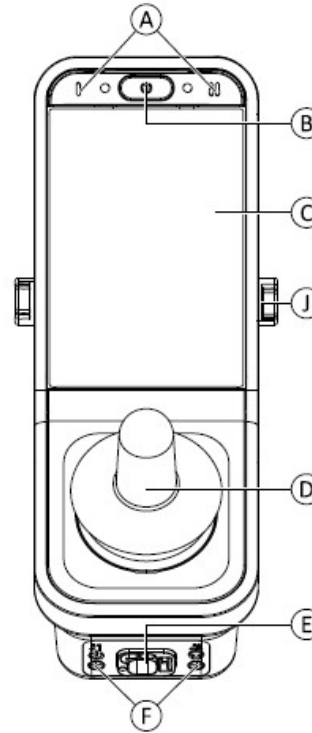

##### DLX-REM400 back

- G - Infrared transmitter
- H - Speaker
- I - Charger socket
- J - Toggle switches

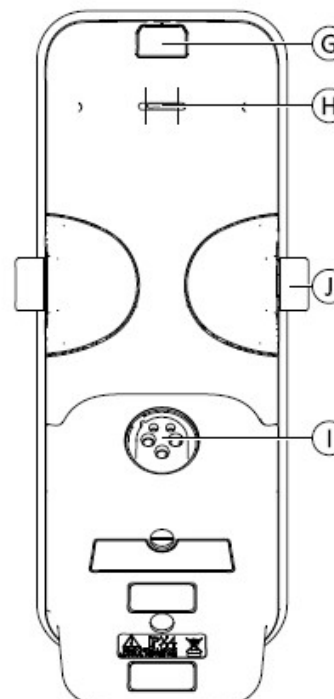

## 3.2. Screen composition overview

### DLX-REM400 screen

- A - Battery bar
- B - Status bar
- C - User function card
- D - Navigation button
- E - Function information

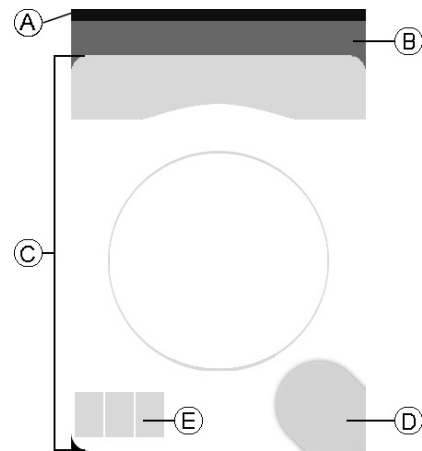

### 3.2.1. BATTERY BAR

The battery bar provides a graphical display of the battery's current state of charge and, when a battery charger is connected, the charging status.

#### Green

Battery bar displays green when state of charge is between 60 and 100%.



#### Orange

Battery bar displays orange when state of charge is between 20 and 59%.



#### Red

Battery bar displays red when state of charge is less than 20%.



#### Sequence

Charging.



### 3.2.2. STATUS BAR

#### Status bar

A - Profile name

The profile name can only be set by the provider.

B - Time

The time is displayed as a 12- or 24-hour clock. It is set using the coordinated universal time (UTC) and an offset based on the location (country) of the user. The UTC is automatically acquired when a system is connected to a programming and diagnostic tool. The country-based offset is set through the remote module's Menu screen.

C - Status information

The status information displays the current state of the LiNX system with status icons.

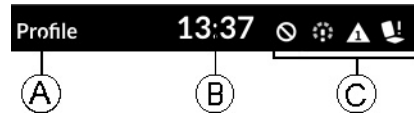

Status Information	Icon
This notifies you that a drive lock-out is active. A drive lock-out is a state that prevents the wheelchair being driven. See 4.4.4 Speed Reduction and Seating Function Inhibits for more information about lock-outs and slow-downs.	
This notifies you that a drive slow-down is active. A drive slow-down is a state that prevents the wheelchair being driven at maximum speed for safety reasons. Instead, the wheelchair is allowed to drive at a reduced speed for the duration of the active drive slow-down. See 4.4.4 Speed Reduction and Seating Function Inhibits for more information about lock-outs and slow-downs.	
This notifies you that a fault occurred. The number indicates the type of fault. See 5.1.1 Fault Codes and Diagnosis Codes for more information about fault codes.	
This notifies you that a seating lock-out is active. A seating lock-out is a state that prevents the wheelchair's seating being operated. See 4.4.4 Speed Reduction and Seating Function Inhibits for more information about lock-outs and slow-downs.	
This notifies you that Bluetooth connectivity is disabled. See 4.6.5 Disabling Bluetooth for more information about disabling Bluetooth.	

Three battery alarms are shown on the right-hand side of the status bar. See 5.1.2 Battery alarms.

### 3.2.3. USER FUNCTION CARD OVERVIEW

#### Left- or Right-Handed

With the LiNX system, it is possible, to adjust the function cards for left-handed or right-handed users.

#### TIPS

Be aware, that in the following manual right-handed function cards are displayed only. All buttons have the same functions for right- and left-handed, so the descriptions can be used for left-handed users, too.

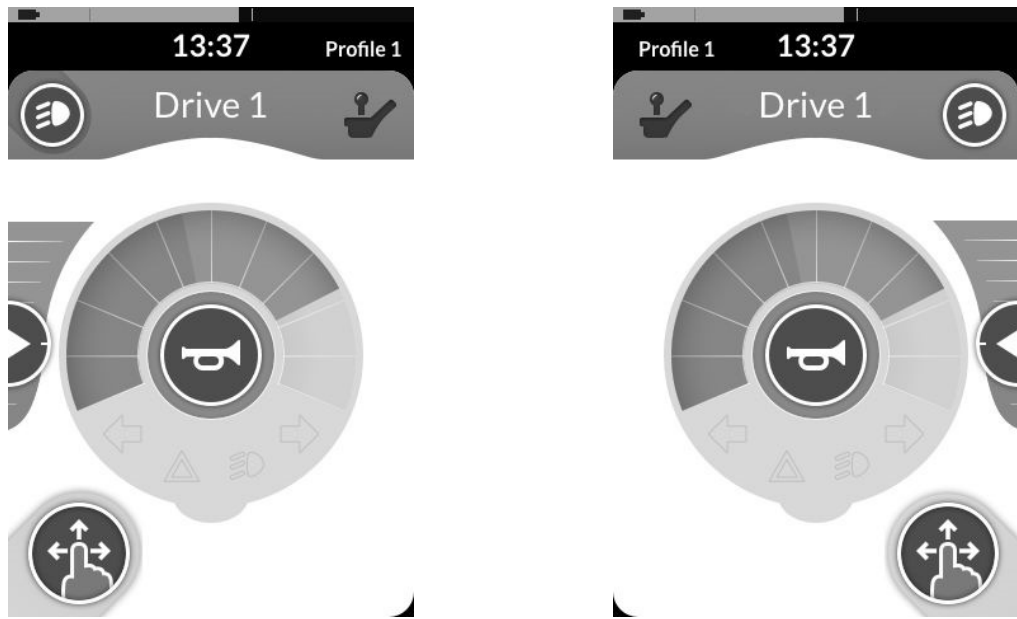

## Function Card Header

The function card type is identified by the color of the function card's header:

- green indicates a drive card,
- orange indicates a seating card,
- blue indicates a connectivity card, and
- purple indicates a utility card.

The icon - A indicates the type of primary input.

The text - B is programmable by your provider and can be used to name the function.

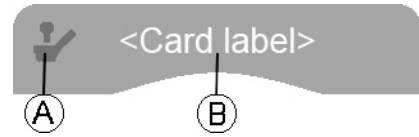

Icon - A meaning	Icon
DLX-REM400 DLX-REM500	
DLX-REM2xx DLX-CR400 DLX-CR400LF	
DLX-ACU200	
Input module or third-party interface	
Head Array	
Sip and Puff	
User switch	

## Drive Card

Drive cards can be pre-set with different maximum speeds to fit your needs and your environment. For example a drive card with pre-set lower maximum speed can be used for indoors and a drive card with pre-set total maximum speed for outdoors. In addition to that you can also control the pre-set maximum speed, see 4.2.2 Controlling the maximum speed.

With a drive card you are also able to sound the horn and to operate the lighting functions. See 4.2.4 Operating the horn and 4.3.1 Operating the position lights.

The function information displays either the latched driving mode or the Gyro indication, see table below.



Drive mode icon meaning	Indicator
No Gyro is connected to the system or enabled for drive function.	no symbol
Gyro disabled.	
Gyro enabled.	

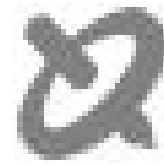

## Seating Card

Seating cards are for operating the seating functions, see 4.4. Operating powered seating functions



## Connectivity Card

Connectivity cards allow you to communicate with external devices. The connectivity functions that are supported by your remote are Mouse Mover and Switch Control. By default, these functions are disabled. Contact your provider to change the configuration.

The mouse mover allows you to control the cursor on a PC or laptop's screen with a user input on the wheelchair, such as the joystick on the remote module or an external joystick. Switch control is an accessibility feature that allows you to navigate and select items on your iOS or Android device using the remote's joystick or touch screen.

For more information about Connectivity cards and how to use them, see 4.6 Configuring Connectivity Cards



### Utility Card, three-quadrant



### Utility Card, four-quadrant

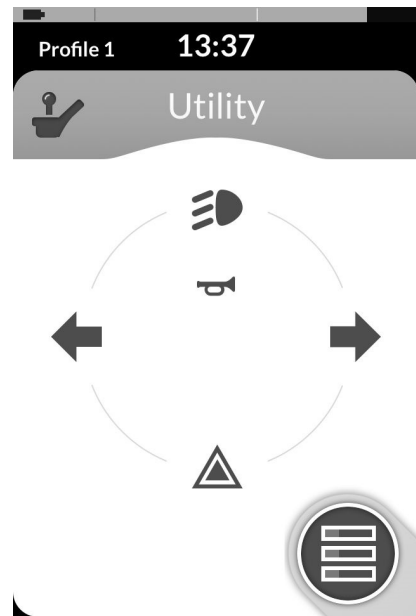

Utility card allows you to operate system controls (such as lighting functions and horn) as well as control outputs with external inputs. The utility card function is suitable for both three-quadrant (3Q) and four-quadrant (4Q) inputs.

Utility card allows you to operate two controls / outputs per quadrant, according to the duration that the user input is activated:

- A - Short press /Momentary press, and
- B - Long press.





















By default, this function is only enabled for chair configurations with an external control input that will not allow the control of horn or lights. Contact your provider to change the configuration and to set up your desired operations.



## Arrangement

User function cards are arranged in rows of profiles. Each profile can hold user function cards, which can be of the same type, for example all drive cards, or can be a mixture of drive, seating and connectivity cards.

The maximum number of function cards across all profiles is 40. In a configuration with five profiles, for example, each profile can hold up to eight function cards.

		Function cards					
		F1	F2	F3	F4	F5	F6
Pro- files	P1						
	P2						
	P3						
	P4						

### 3.3. Navigation button

Depending on the configuration of the remote module and the user's needs, the navigation button is displayed bottom-left or bottom-right on the screen.

When activated, the navigation button changes its color from grey to blue.

The navigation button has two important functions:

---

#### 1. A visual indication of the configured interaction mode

#### Indicator

Configured for swipe-and-tap actions:

This means, that swiping and tapping the screen activates different functions.



---

Configured for tap actions:

This means, that only tapping the screen activates different functions. Swipe inputs are ignored.



---

#### 2. A navigation function depending on context and activation duration

For example, a short press on the navigation button, while viewing an active user function card, opens the card preview display. A long press opens the status screen.

Additional to the touch display, external inputs can be used to interact with the system.

---

## 4. USAGE.

### 4.1. Operating the remote

#### 4.1.1. POWERING UP / DOWN THE REMOTE

##### Power button

##### Powering up

- Press ON/OFF button - A.
- Start screen lights up.

The status LED inside the ON/OFF button lights up green, if no fault is present at power up. After a few seconds display is ready to use.

If there is a fault with the system when powering up, the status LED indicates the fault with a series of red flashes, also a fault icon is displayed in the status bar. For more information about fault indication, refer to 5.1.1 Fault Codes

##### Powering down

- Press ON/OFF button - A.
- Shut down screen is displayed.

After a few seconds the remote is powered down.

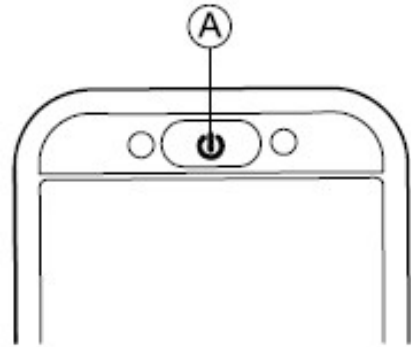

#### 4.1.2. USING THE MULTIPURPOSE BUTTONS

##### Multipurpose buttons

By default, you can change profiles and function cards with the multipurpose buttons.

1. Press left button - A to switch to next profile.
2. Press right button - B to switch to next function card.

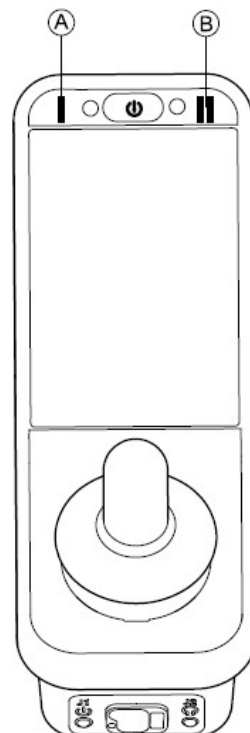

### 4.1.3. USING THE TOGGLE SWITCHES (OPTIONAL)

#### Toggle Switches

The toggle switches are an alternative means to switch commonly-used controls and can be an option for users who, for example have difficulties to reach the ON/OFF key, multipurpose buttons or struggle to operate certain areas of the touch screen of the remote.

When the switches are deflected forwards or backwards from the neutral position, the programmed action is performed. If the switches are released, the switches return to the neutral position.

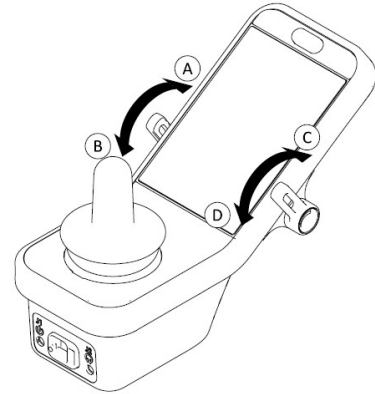

By default, the following actions are performed:

(A)	Left toggle switch	Forward command	Power button (On / Off)
(B)		Backwards command (short press)	switch to next function card
		Backwards command (long press)	Switch to next profile
(C)	Right toggle switch	Forward command	Increase speed by 10 %
(D)		Backwards command	Decrease speed by 10 %

## 4.2. Operating the drive function

### 4.2.1. USING THE JOYSTICK

#### Joystick

The speed of the wheelchair is proportional to the joystick deflections, so that the further the joystick is moved from the neutral position, the faster the wheelchair travels.

If the joystick is moved back to the neutral position, the wheelchair slows down and stops.

If the joystick is released from any position other than the neutral position, the joystick returns to the neutral position and the wheelchair slows down and stops.

The joystick can also be used to wake up the system when in sleep mode, if this parameter has been enabled by the provider. Refer to 5.14 The sleep mode, page 53.

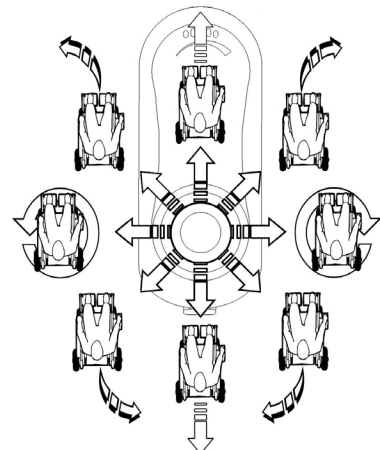

## 4.2.2. CONTROLLING THE MAXIMUM SPEED

### Speed slider

The speedometer is divided into ten segments, representing the speed range of the wheelchair. Each segment can be displayed in one of three colors.

- The green section A displays the speed range, determined by the set point E on the speed slider D.
- The yellow section B displays the pre-set maximum speed range C, depending on the programming of the drive card.
- The grey section F displays that the total maximum speed range of the wheelchair is not reached in the depending drive function.

In each drive card you are able to control the pre-set maximum speed depending on your needs.

The proportion of the green sections A and yellow sections B on the speedometer and the speed slider correspond to the position of the set point E.

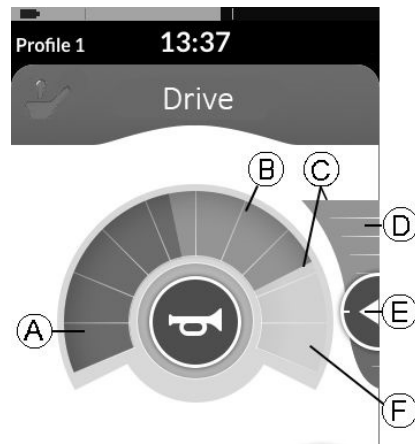

## 4.2.3. EMERGENCY STOP

### Power button

If you press the ON/OFF button - A while driving, an emergency stop is carried out. The remote powers down after this.

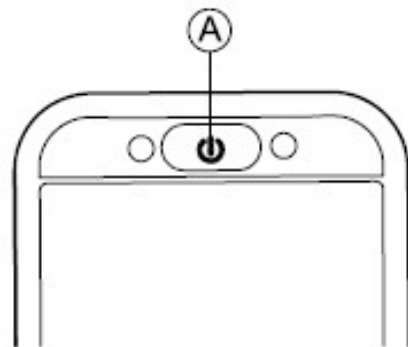

## 4.2.4. USING THE HORN

### Horn button

Tap horn button A to sound horn.  
Horn sounds as long as button is tapped.



## 4.3. Operating the light functions

### 4.3.1. USING THE POSITION LIGHTS

If you drive outside, turn on the position lights under bad visibility conditions or darkness. To operate the position lights, you need to stop the mobility device.

#### Light button

##### Turn on position lights

- Tap Lighting control button - A.



The Lighting button panel opens.

- Tap Position lights symbol - B.

Position lights turn on. Position lights telltale becomes illuminated in the lighting dashboard.

- Tap button - C to close Lighting button panel.

If you start driving, the Lighting button panel overlay disappears automatically and the position lights remain turned on.

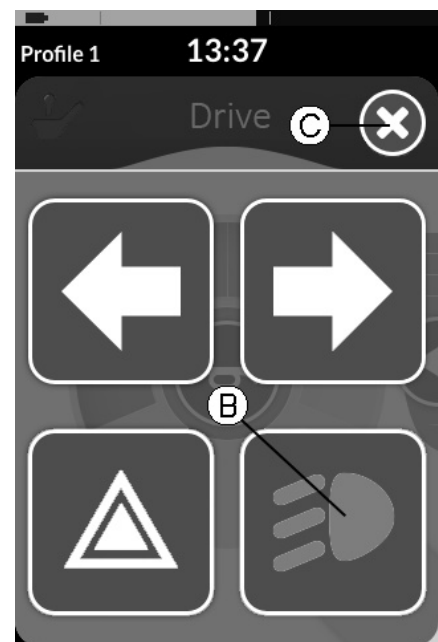

##### Turn off position lights

Use the same procedure as for turning on the lights, see figures above:

- Tap Lighting control button - A.

The Lighting button panel will appear.

- Tap Position lights symbol - B.

Position lights turn off.

- Tap button - C to close Lighting button panel.

If you start driving, the Lighting button panel overlay disappears automatically.

### 4.3.2. USING THE DIRECTION INDICATORS

To operate the direction indicators, you need to stop the mobility device.

#### Light button

##### Turn on direction indicators

- Tap Lighting control button - A.



The Lighting button panel opens.

- Tap left direction indicator symbol - B or right direction indicator symbol - C.

Either left or right direction indicator turns on. Left or right indicator telltale becomes illuminated in the lighting dashboard.

- Tap button - D to close Lighting button panel.

If you start driving, the Lighting button panel overlay disappears automatically.

After more than ten seconds, the direction indicators turn off automatically.

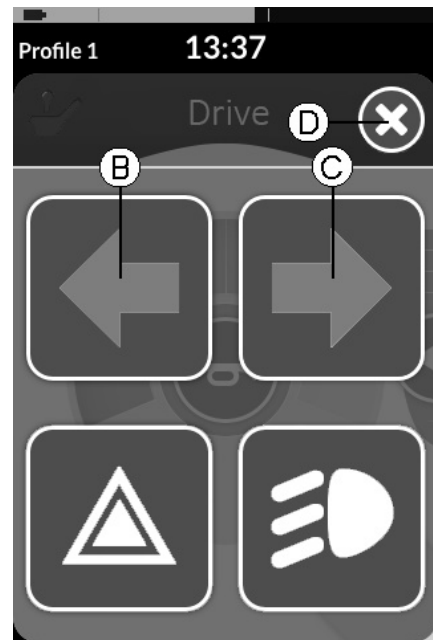

##### Turn off direction indicators

After more than ten seconds, the direction indicators turn off automatically, but they can be turned off earlier by using the same procedure as for turning them on, see figures above:

- Tap Lighting control button - A.

The Lighting button panel will appear.

- Tap left direction indicator symbol - B or right direction indicator symbol - C.

Either left or right direction indicator turns off.

- Tap button - D to close Lighting button panel.

If you start driving, the Lighting button panel overlay disappears automatically.

### 4.3.3. USING THE HAZARD LIGHTS

To operate the hazard lights, you need to stop the mobility device.

#### Light button

##### Turn on hazard lights

- Tap Lighting control button - A.



The Lighting button panel opens.

- Tap Hazard lights symbol - B.

Hazard lights turn on. Hazard lights telltale becomes illuminated in the lighting dashboard.

- Tap button - C to close Lighting button panel.

If you start driving, the Lighting button panel overlay disappears automatically and the hazard lights remain turned on.

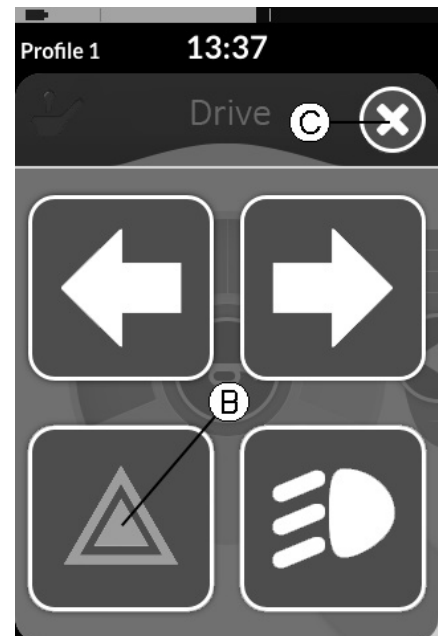

##### Turn off hazard lights

Use the same procedure as for turning on the hazard lights, see figures above:

- Tap Lighting control button - A.

The Lighting button panel will appear.

- Tap Hazard lights symbol - B.

Hazard lights turn off.

- Tap button - C to close Lighting button panel.

If you start driving, the Lighting button panel overlay disappears automatically.

## 4.4. Operating powered seating functions

### 4.4.1. ACTIVATING SEATING FUNCTIONS

Powered seating functions, such as powered elevating legrests or powered recline, are carried out as described below.

#### Through Seating Cards

By default, every seating card displays a single powered seating function. Different configurations are listed below. Contact your provider to change the configuration.

Choose the seating card with the seating function you want to operate.

Give forward or reverse demand to operate seating function. When a motion becomes active, navigation button disappears A, the active direction of the motion B is displayed, the other becomes inactive C and drive inhibit/lockout icon D is displayed in the status bar. Motion is deactivated as soon as demand is released or when motion reaches its end-of-travel.



#### Through Four quadrant configuration

The displayed function cards are configuration examples only.

- A - Powered recline up
- B - Seat lifter up
- C - Seat lifter down
- D - Powered recline down



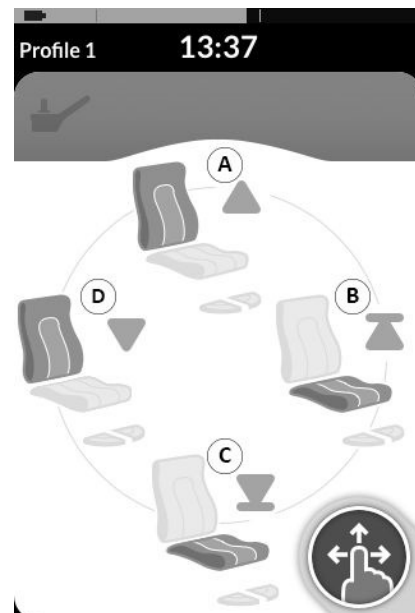

All four quadrants are used for operating powered seating functions.

Give and hold forward - A, reverse - C, left - D or right demand - B to operate seating function. Motion is deactivated as soon as demand is released or when motion reaches its end-of-travel.



#### 4.4.2. DISPLAYED SYMBOLS AND THEIR MEANINGS

Not every wheelchair has all options.

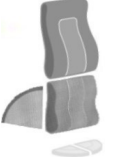
Function	Symbol
Seat tilt	
Recline	
Seat lifter	
Left or center-mount powered elevating legrest	
Right powered elevating legrest or center-mount powered length adjustment legrest	
Both powered elevating legrests or center-mount powered elevating legrest with length compensation	
Recline and legrest	
Stand-up function	

### 4.4.3. THE 10WAY SWITCH MODULE OR EXTERNAL SWITCHES

#### Through button 1 to 10 on 10way- or external switch

Press and hold button to move particular seating function. Seating function moves as long as button is pressed.

Standard programming is shown below, but this may vary.

- A - Recline forward
- B - Recline backwards
- C - Lifter up
- D - Lifter down
- E - Legrest tilt down
- F - Legrest tilt up
- G - Legrest length out
- H - Legrest length in
- I - Tilt forward
- J - Tilt backwards

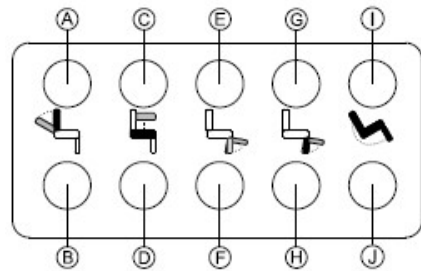

With 10way- or an external switch, seating functions can be controlled while driving and without using seating cards. When the seating function is activated without a seating card, a small overlay is displayed on the touch display, to inform the user, that the seating is being controlled externally. The overlay remains on the touch display for the duration of the seating operation. The following symbols will be displayed:

Seat tilt



Recline



Seat lifter



Left or center-mount powered elevating legrest



Right powered elevating legrest or center-mount powered length adjustment legrest



Both powered elevating legrests or center-mount powered elevating legrest with length compensation



Recline and legrest



#### 4.4.4. SPEED REDUCTION AND SEATING FUNCTION INHIBITS

If the lifter has been adjusted above a certain point, the drive electronics considerably reduces the speed of the wheelchair. If speed reduction has been activated, drive mode can only be used to carry out movements in reduced speed and not for regular driving. To drive normally, adjust the lifter until the speed reduction has been deactivated again.

##### Speed reduction

Speed reduction is shown in the display. If the seat lifter is raised above a certain point, this icon is displayed in the status bar. This indicator remains active until speed reduction is deactivated again by lowering the lifter.



##### Seating function inhibits

The maximum tilt limit switch is a function to prevent the seat tilt or recline from extending beyond a maximum pre-set angle. The seating electronics stops automatically further adjustment, a grey exclamation point is displayed on the seating card and tilting or reclining backwards is inhibited - A.



## 4.5. Operating locking and sleep function

### 4.5.1. LOCKING/UNLOCKING THE REMOTE

#### Power button

##### Locking the remote

By default, lock function is disabled. Contact your provider to change the configuration.

If function is enabled, the system can be locked / unlocked using below described sequence.

- Press ON/OFF button for more than three seconds, until a locking overlay is displayed.
- Remote powers down.  
When powering up remote, locking overlay is displayed.



#### Power button and Tap on screen

##### Unlocking the remote

- Press ON/OFF button.
- Tap on locked display until white frame around locking screen - A is filled.
- Touch display is unlocked and can be used again.

##### TIPS

If you do not apply the unlock sequence or the ON/OFF button is pressed again before the unlock sequence is complete, the system returns to the locked state and powers down.

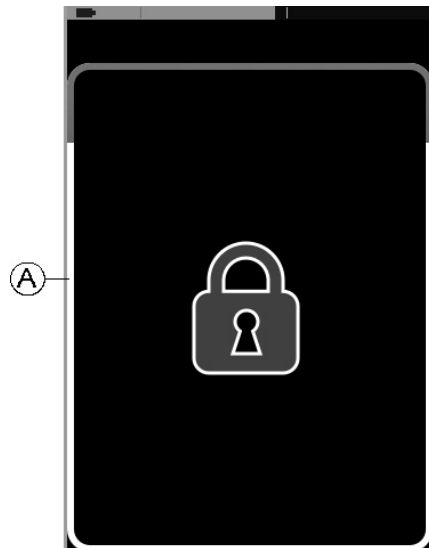

### 4.5.2. THE SLEEP MODE

The sleep mode is no factory setting, but can be enabled by your provider. If this parameter is set ON, the system goes into sleep mode after a period of time without user activity. This period can be set by the provider.

Before a system goes into sleep mode, the system enters a transition period. During the transition period, the touch display and all indicators slowly dim until they are switched off.

During this transition period sleep mode can be interrupted by performing any input by moving the joystick, pressing the ON/OFF button or tapping on the touch display.

To wake the system from sleep mode, move the joystick or either press the ON/OFF button, if this parameter has been enabled by your provider.

## 4.6. Configuring connectivity card

Connectivity cards allow you to communicate with external devices. Connectivity functions supported by your remote are a mouse mover and a switch control. By default, these functions are disabled. Contact your provider to activate Connectivity Cards.

The mouse mover function allows you to control the cursor on a PC or laptop's screen with a user input on the wheelchair, such as the joystick on the remote module or external joysticks. At the moment a four-quadrant operation is needed to use the mouse mover.

The switch control function is an accessibility feature that allows you to navigate and select items on your mobile device (Android and iOS) using the remote's joystick or touch screen.

### 4.6.1. PAIRING THE LINX SYSTEM WITH A USER'S DEVICE

#### Connectivity

To pair the LiNX system with a user's device (PC, laptop or mobile device), open the connectivity settings menu.

- Long press navigation button - A.

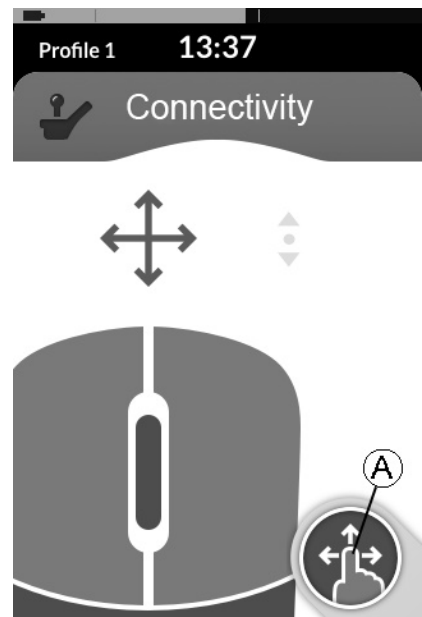

Status display opens.

- Tap Settings menu - B.

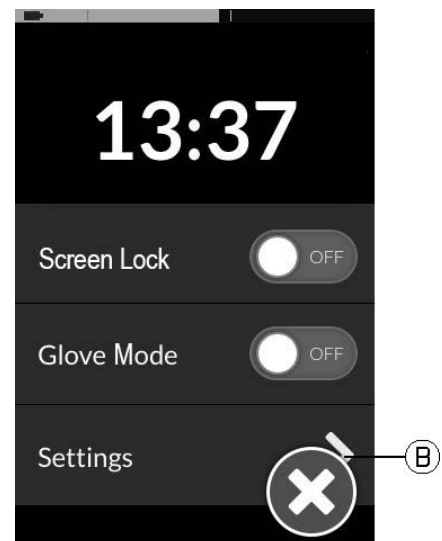

Settings menu opens.

- Tap Connectivity settings - C.

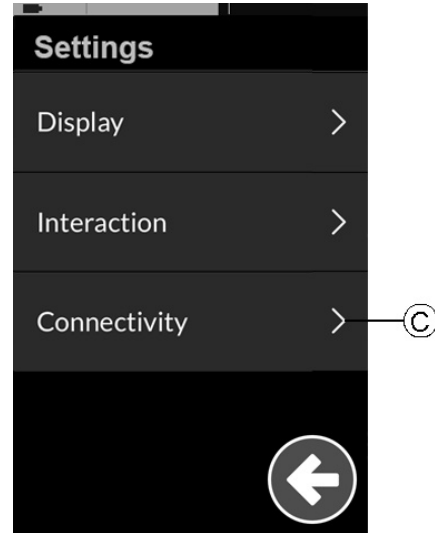

Connectivity settings menu opens. This menu is split into two sections:

D - Functions

E - Paired devices

- Tap on Pair New Device button - F at bottom of menu.

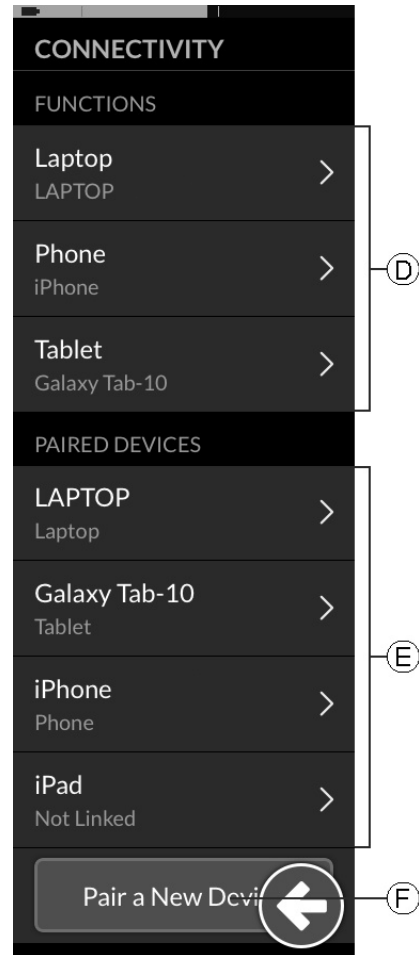

Pairing passkey is displayed on touch screen with the name of LiNX device to pair with, in this example REM-J16130951.

### Pairing mobile device with LiNX system

Perform this operation promptly to the Pairing process on your remote (see 4.6.1 Pairing the LiNX system with a user's device). Otherwise, a timeout will occur.

See your mobile device's user manual for information about how to establish a Bluetooth connection with your remote.

### Pairing PC or Laptop with LiNX system

Open Devices and Printers dialog box on your Windows PC or laptop.

There are a number of ways to do this:

- Start → Devices and Printers,
- Start → Control Panel → Devices and Printers,
- Icon tray → click on Bluetooth Device icon

From Devices and Printers dialog box, click on Add a device button.

All available devices are displayed. Locate LiNX device name that as displayed on the touch screen (REM-J16130951) and select it.

Click on Next button.

Wait for device to connect.

Click on Next as soon as device is connected.

Click on Close button to complete Add a device action.

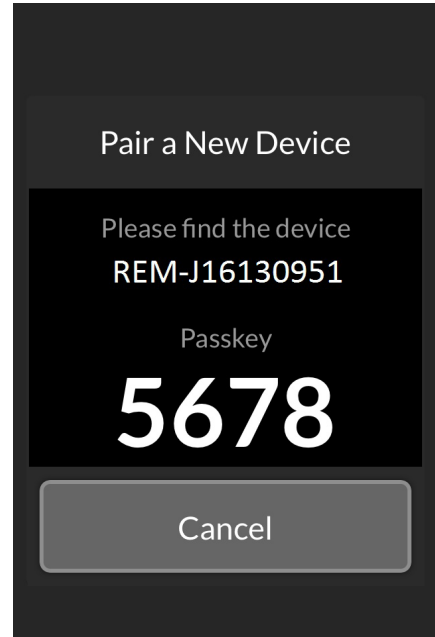

If the device paired successfully, a confirmation screen is displayed on the remote module. Tap on the OK button to proceed.

If no device is paired within the set timeout period, a message is displayed "No device was paired". Tap on OK button to proceed.

LiNX system permits up to ten devices to be paired at any time. If you have reached this limit and you need to add more devices, consider forgetting devices, that have already been paired, see 4.6.4 Remove paired devices.

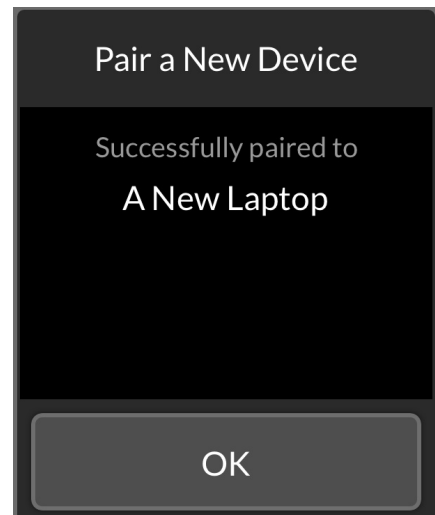

#### 4.6.2. LINKING CONNECTIVITY CARD WITH USER'S DEVICE

### Connectivity

Connectivity cards must be linked to a paired device. To link a connectivity card to a device, open the connectivity settings menu.

- Long press navigation button - A.



Status display opens.

- Tap Settings menu - B.

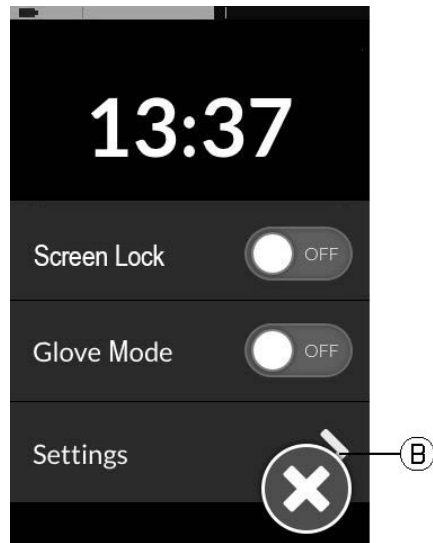

Settings menu opens.

- Tap Connectivity settings - C.

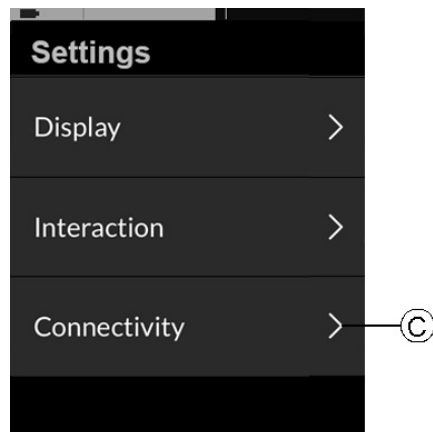

The names of the connectivity cards are displayed in section Functions.

A - Function name

B - Linked device

C - No linked device

- Tap on appropriate menu item to link connectivity card with a paired device.

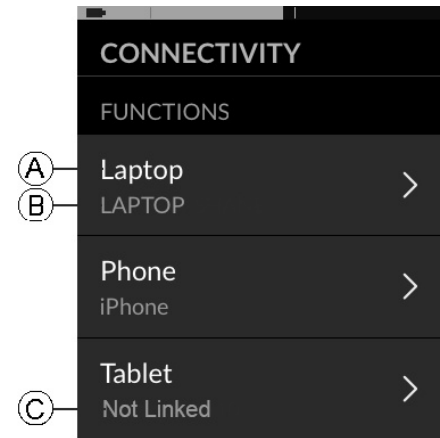

If you uses Mouse mover function card, cursor speed settings are displayed on top. Scroll down to section Function Uses Device.

- Tap on Not Linked button - D.

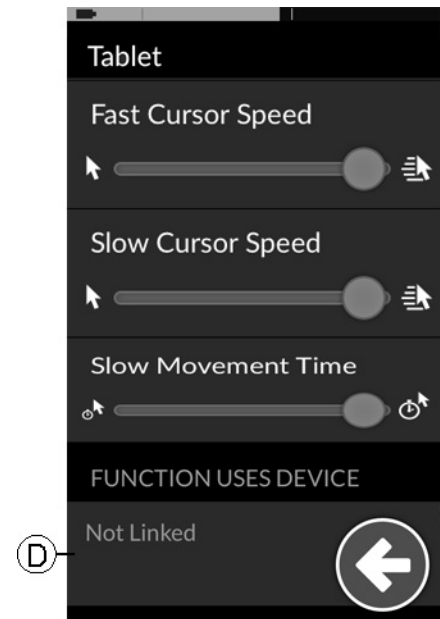

Select one of paired devices in list - E, or tap on Pair New Device button - F to pair with new device.

Currently active device is identified by a green hook behind the device name.

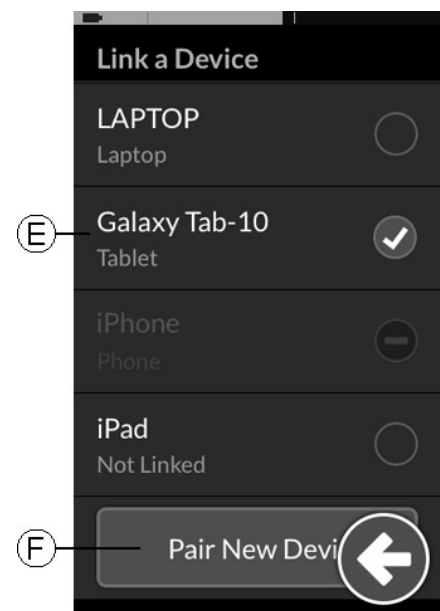

### 4.6.3. CONNECTING DEVICES WITH LINX SYSTEM

To connect to a device, select the appropriate connectivity card from a profile. If the connectivity function has been paired to a device and the device has been linked to the function, then it attempts to connect to the device via Bluetooth.

The Bluetooth status indicator shows when the Bluetooth connection between the LiNX system and the user's device is:

Indicator	Symbol
Disconnected	
Connecting	
Connected	

If the Bluetooth fails to connect, the status reverts to disconnected.

#### 4.6.4. REMOVING PAIRED DEVICES

##### Connectivity

LiNX system permits up to ten devices to be paired at any time. If you have reached this limit and you need to add more devices, consider forgetting devices, that have already been paired

- Long press navigation button - A.



Status display opens.

- Tap Settings menu - B.

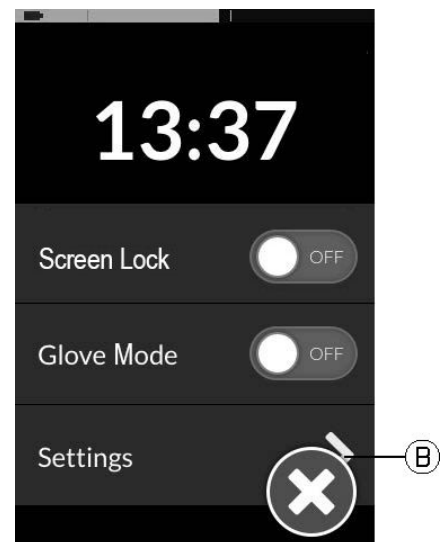

Settings menu opens.

- Tap Connectivity settings - C.

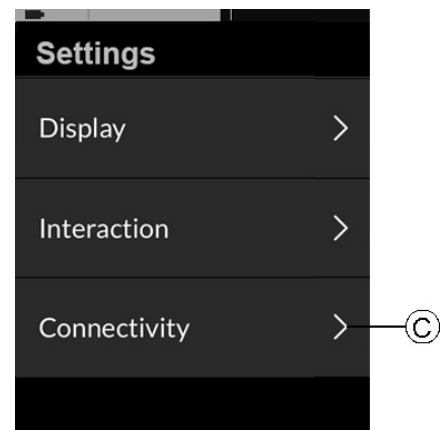

Select paired device in section Paired Devices, e. g. Laptop - D.

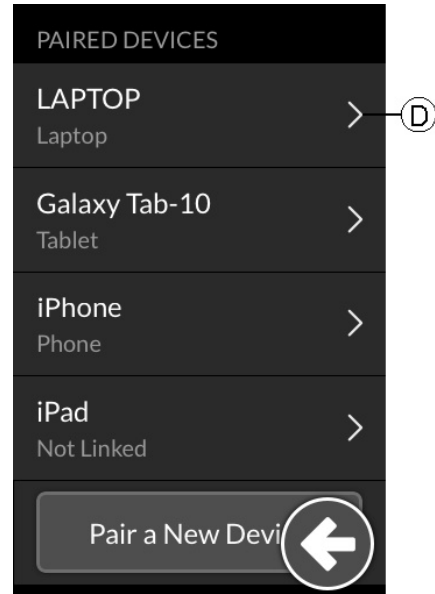

Check details on following screen and tap Forget this Device button.



Tap on Forget this Device button again or Cancel button, to cancel removing.

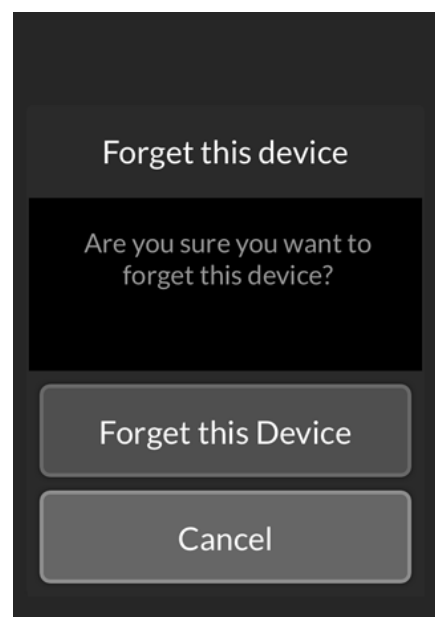

#### 4.6.5. DISABLING BLUETOOTH

The embedded Bluetooth functionality can be disabled when powering up the system.

##### Power button

- Press and hold the ON/OFF button for more than three seconds.

The disabled Bluetooth functionality is indicated by an icon in the status bar and the status LED inside the ON/OFF button pulsing for a duration of six seconds.

Bluetooth functionality resumes the next time the system is powered up again.



### 4.7. Charging the batteries



#### WARNING

Using the wrong battery charger may cause explosion and destruction of batteries. To avoid injury or damage:

- Only use the battery charger supplied with your wheelchair, or a charger that has been approved by Baldertech.



#### WARNING

Explosive gases can be generated while charging.

To avoid flammable gas buildup and injury or damage due to explosion:

- During charging, keep the wheelchair and battery charger away from sources of ignition, such as flames and sparks.
- Charge the wheelchair in a space at least twice the volume of the wheelchair.

#### NOTE

Refer to the charger user manual, the power wheelchair base user manual and instructions supplied with the batteries for more information concerning charging the batteries.

#### 4.7.1. CONNECTING THE CHARGER

##### Charger socket

- Plug the battery charger into the remote's charger socket - A.

If the remote is powered up, the battery gauge indicates the system is connected to the charger by cycling between a left-to-right chase sequence, and then displaying the approximate battery charge state at the end of the chase sequence.

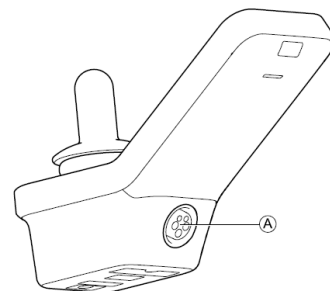

The battery charging status is shown in the battery gauge.

### **Below 20%**

Battery bar displays red when charge is <20%.



### **Between 20 and 60%**

Battery bar displays orange when charge is between 20 and 60%.



### **Between 60 and 100%**

Battery bar displays green when charge is between 60 and 100%.



## **5. TROUBLESHOOTING**

### **5.1. Fault diagnosis**

If the electronic system shows a fault, use the following fault-finding guide to locate the fault.

#### **TIPS**

Ensure that the drive electronics system is powered up before starting any diagnosis.

#### **If the status display is OFF:**

- Check whether the drive electronics system is powered up.
- Check whether all cables are correctly connected.
- Ensure that the batteries are not discharged.

#### **If a fault number is displayed in the status display:**

- Proceed to the next section.

## 5.1.1. FAULT CODES AND DIAGNOSIS CODES

### Status bar and Power button

If there is a fault with the system when it is powered up, a fault icon A is displayed in the status bar. The number inside the triangle indicates the type of fault.



Corresponding to that, the status LED inside the ON/OFF button flashes red. The number of flashes is identical to the one in the status bar.

The table below describes the fault indication, and a few possible actions that can be taken to rectify the problem. The actions listed are not in any particular order and are suggestions only. The intention is that one of the suggestions may help you clear the problem. If in doubt, contact your provider.

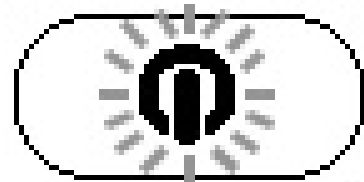

Flash code	Fault description	Possible action
1	Remote fault	<ul style="list-style-type: none"> <li>• Check cables and connectors.</li> <li>• Contact your provider.</li> </ul>
2	Network or configuration fault	<ul style="list-style-type: none"> <li>• Check cables and connectors.</li> <li>• Recharge the batteries.</li> <li>• Check charger.</li> <li>• Contact your provider.</li> </ul>
3	Left motor fault	<ul style="list-style-type: none"> <li>• Check cables and connectors.</li> <li>• Contact your provider.</li> </ul>
4	Right motor fault	<ul style="list-style-type: none"> <li>• Check cables and connectors.</li> <li>• Contact your provider.</li> </ul>
5	Left magnetic brake fault	<ul style="list-style-type: none"> <li>• Check cables and connectors.</li> <li>• Check left magnetic brake is engaged.</li> <li>• Refer to the chapter “disconnecting the breaks/drive motors” in the user manual of your wheelchair.</li> <li>• Contact your provider.</li> </ul>
6	Right magnetic brake fault	<ul style="list-style-type: none"> <li>• Check cables and connectors.</li> <li>• Check right magnetic brake is engaged.</li> <li>• Refer to the chapter “disconnecting the breaks/drive motors” in the user manual of your wheelchair.</li> <li>• Contact your provider.</li> </ul>
7	Module fault (other than remote module)	<ul style="list-style-type: none"> <li>• Check cables and connectors.</li> <li>• Check modules.</li> <li>• Recharge batteries.</li> <li>• If the chair was stalled, reverse away or remove obstacle.</li> <li>• Contact your provider.</li> </ul>

## BATTERY ALARMS

Three battery alarms are shown on the right-hand side of the status bar:

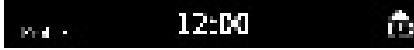
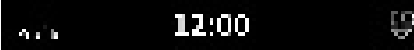
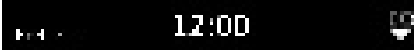
Indicator	Symbol
<p>Over voltage</p> <p>This is displayed if the batteries are overcharged. Disconnect the battery charger immediately.</p>	
<p>Low voltage</p> <p>This is displayed if the batteries are empty. Power down the wheelchair and charge the batteries immediately.</p>	
<p>Deep discharge</p> <p>This is displayed if the battery voltage falls below the voltage set by Cut Off Voltage. This indicates that the battery is empty and battery damage occurs if the battery is discharged any further. The horn also sounds once every ten seconds for the duration of active deep discharge status. Power down the wheelchair and charge the batteries.</p>	

## 5.2. OON (“Out Of Neutral”)

OON (“Out Of Neutral”) is a safety feature that prevents accidental driving or seating movements, when:

- the system is powering up,
- after a function change or
- when the system comes out of an inhibit or drive lock-out.

### OON warning

#### Drive OON warning

The joystick must be in the center position:

- when a system is powering up,
- on a function change or
- when transitioning from a drive lock-out or inhibit state.

Otherwise a drive OON warning is displayed. During a drive OON warning, the OON overlay is displayed and the wheelchair does not drive. If the joystick is returned to the center position, the warning clears and the wheelchair drives normally.

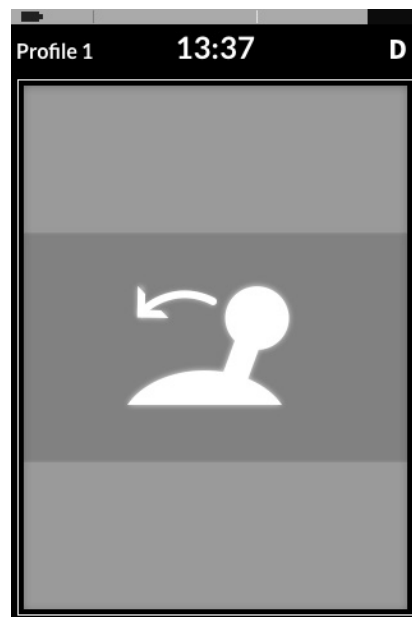

### Seating OON warning

When a system is powering up or after a function change, no direct access switches can be active, otherwise a seating OON warning is displayed.

During a seating OON warning, the OON overlay is displayed and the seating motions do not operate. If the switches are deactivated, the warning clears and the seating motions operate normally.

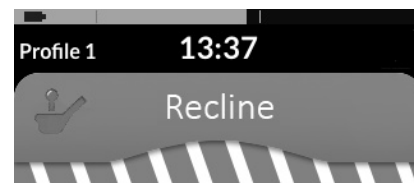

## 6. TECHNICAL DATA

### 6.1. Mechanical specifications

#### Permissible operating, storage and humidity conditions

Temperature range for operation according to ISO 7176-9	• -25° ... +50 °C
Recommended storage temperature	• 15 °C
Temperature range for storage according to ISO 7176-9	• -40° ... +65 °C
Operating humidity range according to ISO 7176-9	• 0 ... 90 %RH
Rigt motor fault Degree of protection	• IPX4

#### Operating forces

Joystick	• 1.9 N
Power button	• 2.5 N

### 6.2. Electrical specifications

Parameter	Min.	Nominal	Max.	Units
Operating voltage (Vbatt)	• 17	• 24	• 34	• V
Idle current		• 70		• mA at 24V
Quiescent current (power off)			• 0.23	• mA at 24V



## 7. CONTACTS

### **Baldertech AS**

Email : [info@baldertech.com](mailto:info@baldertech.com)

Telephone : +47 32 11 11 00

[www.baldertech.com](http://www.baldertech.com)

Label serial number

**Baldertech AS**

Email : [info@baldertech.com](mailto:info@baldertech.com)

Telephone : +47 32 11 11 00

[www.baldertech.com](http://www.baldertech.com)

**baldertech**